

Title: Realistic Model for 5 Ohm Film Leaded Resistor
 Treatment: None

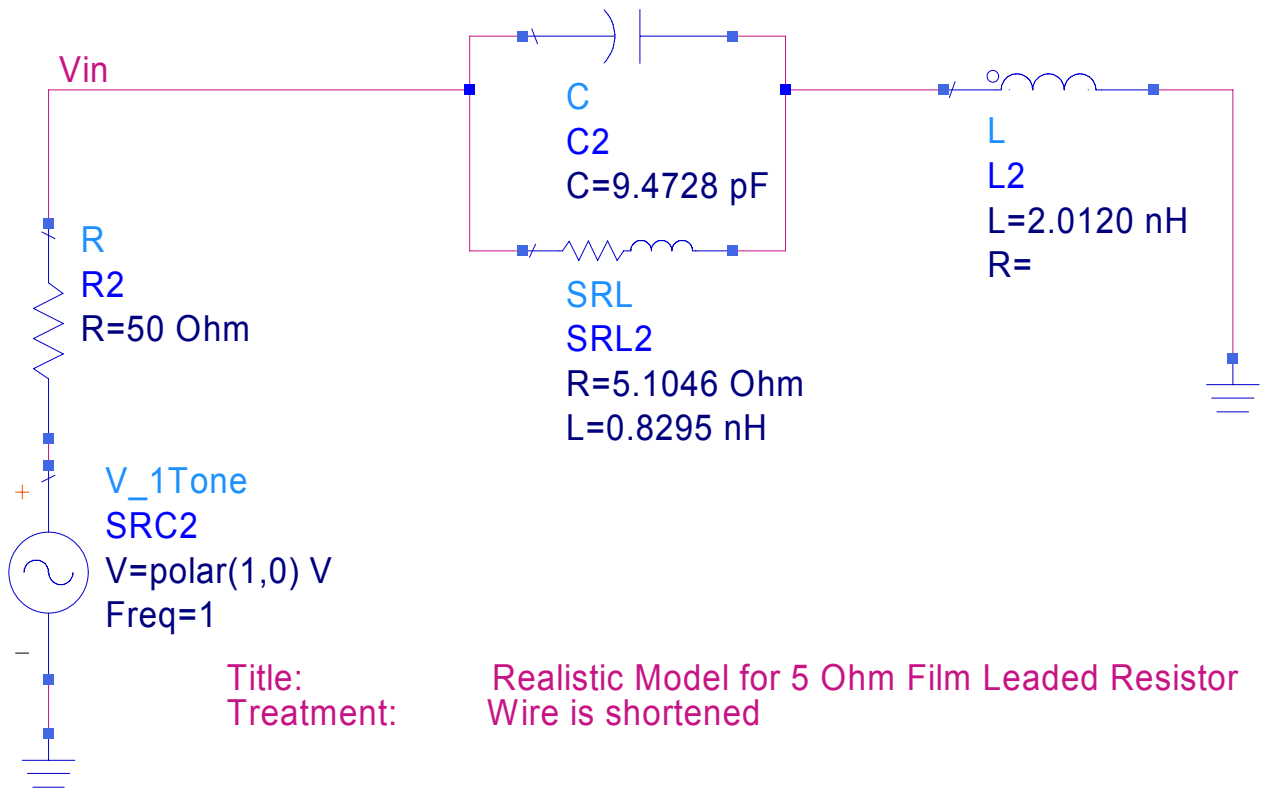

Title: Realistic Model for 5 Ohm Film Leaded Resistor
 Treatment: Wire is shortened